

DeviceNet Digital Remote I/O

■ Features

- Automatic communication speed recognition
: Enables to recognize communication speed automatically when connecting with master
- Network Voltage monitoring
: If PV is lower than SV, enables to receive error flag for network power monitoring as Explicit message.
- Additional expansion units
 - Standard terminal block type: Connectable up to 3 expansion units
 - Sensor connector type: Connectable up to 7 expansion units
 - Expandable I/O points up to max. 64 points for Standard terminal type, sensor connector type
- Reading the number of expansion units
: Reads the number of connected expansion units
- Reading model name: Reads the connected model name of connected units (sensor connector type)
- Reading the unit specifications: Reads the specifications of connected units



Standard terminal block type



Sensor connector type

⚠ Please read "Safety Considerations" in the instruction manual before using.



■ Ordering Information

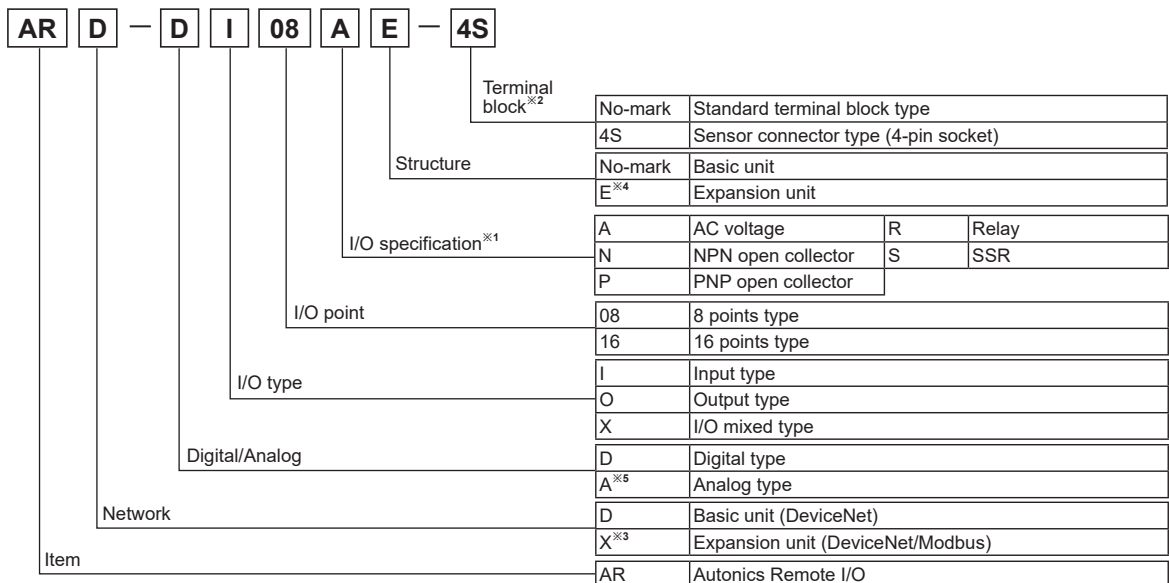

※1: Sensor connector type (ARD-□□□-4S) model is only for NPN, PNP I/O specifications.
 ※2: Sensor connector (CNE-P04-□) is sold separately.
 ※3: It is only for an expansion unit of sensor connector type.
 ※4: It is only for an expansion unit of standard terminal block type.
 ※5: For analog type, refer to 'ARD-A Series'.

- SENSORS
- CONTROLLERS
- MOTION DEVICES
- SOFTWARE
- (J) Temperature Controllers
- (K) SSRs
- (L) Power Controllers
- (M) Counters
- (N) Timers
- (O) Digital Panel Meters
- (P) Indicators
- (Q) Converters
- (R) Digital Display Units
- (S) Sensor Controllers
- (T) Switching Mode Power Supplies
- (U) Recorders
- (V) HMIs
- (W) Panel PC
- (X) Field Network Devices

ARD-D Series

■ Models

Models			Specification
Terminal type	Basic unit	Expansion unit	
Standard terminal block type	ARD-DI08A	ARD-DI08AE	75-250VAC input 8-point (13mA/point)
	ARD-DI16N	ARD-DI16NE	10-28VDC NPN input 16-point (10mA/point)
	ARD-DI16P	ARD-DI16PE	10-28VDC PNP input 16-point (10mA/point)
	ARD-DO08R	ARD-DO08RE	Relay output 8-point (2A/point), Life cycle of contact: 100,000 times
	ARD-DO08S	ARD-DO08SE	SSR output 8-point (1A/point)
	ARD-DO16N	ARD-DO16NE	10-28VDC NPN output 16-point (0.5A/point)
	ARD-DO16P	ARD-DO16PE	10-28VDC PNP output 16-point (0.5A/point)
	ARD-DX16N	ARD-DX16NE	10-28VDC NPN input 8-point (10mA/point), NPN output 8-point (0.5A/point)
	ARD-DX16P	ARD-DX16PE	10-28VDC PNP input 8-point (10mA/point), PNP output 8-point (0.5A/point)
Sensor connector type	ARD-DI08N-4S	ARX-DI08N-4S	10-28VDC NPN input 8-point (10mA/point)
	ARD-DI08P-4S	ARX-DI08P-4S	10-28VDC PNP input 8-point (10mA/point)
	ARD-DO08N-4S	ARX-DO08N-4S	10-28VDC NPN output 8-point (0.3A/point)
	ARD-DO08P-4S	ARX-DO08P-4S	10-28VDC PNP output 8-point (0.3A/point)

■ Specifications

◎ Standard terminal block type

Model	Basic unit	ARD-DI08A	ARD-DI16N	ARD-DI16P	ARD-DO08R	ARD-DO08S	ARD-DO16N	ARD-DO16P	ARD-DX16N	ARD-DX16P
	Expansion unit	ARD-DI08AE	ARD-DI16NE	ARD-DI16PE	ARD-DO08RE	ARD-DO08SE	ARD-DO16NE	ARD-DO16PE	ARD-DX16NE	ARD-DX16PE
Power supply		Rated voltage: 24VDC \equiv , Voltage range: 12-28VDC \equiv								
Power consumption		Max. 3W								
I/O points		AC input 8-point	NPN input 16-point	PNP input 16-point	Relay output 8-point	SSR output 8-point	NPN output 16-point	PNP output 16-point	NPN input 8-point + output 8-point	PNP input 8-point + output 8-point
Control I/O	Voltage	75-250VAC \sim	10-28VDC \equiv		Normally open (N.O.) 250VAC \sim 2A 1a	30-250VAC \sim	10-28VDC \equiv (voltage drop: max. 0.5VDC \equiv)			
	Current	13mA/point	10mA/point			1A/point	0.5A/point (leakage current: max. 0.5 mA)		Input: 10mA, Output: 0.5A/point (leakage current: max. 0.5mA)	
	COMMON method	8-point, common			1-point, COM	8-point, common				
Insulation resistance		Over 200M Ω (at 500VDC megger)								
Noise immunity		\pm 240V the square wave noise (pulse width: 1 μ s) by the noise simulator								
Dielectric strength		1,000VAC 50/60 Hz for 1 min								
Vibration		1.5mm amplitude at frequency of 10 to 55Hz (for 1 min) in each X, Y, Z direction for 2 hours								
Shock		500m/s ² (approx. 50G) in each X, Y, Z direction for 3 times								
Environment	Ambient temp.	-10 to 50°C, storage: -25 to 75 °C								
	Ambient humi.	35 to 85%RH, storage: 35 to 85%RH								
Protection structure		IP20 (IEC standard)								
Protection circuit		Surge protection circuit, reverse polarity protection circuit (common) <ul style="list-style-type: none"> Transistor output type - Overcurrent protection circuit (NPN type: operated at min. 1.9A \rightarrow re-supply power in overcurrent status, PNP type: operated at min. 0.7A), Overheat protection circuit (over 165°C), Short-circuit protection circuit 								
Indicator		Network status (NS) LED (green, red), unit status (MS) LED (green, red), I/O status LED (input: green, output: red)								
Material		Front case, body case: Polycarbonate, Rubber cap: acrylonitrile-butadiene rubber								
Mounting		DIN rail or bolt mounting type								
Approval		Devicenet CE Devicenet		Devicenet			CE Devicenet			
Unit weight		Approx. 150g	Approx. 140g		Approx. 160g	Approx. 170g	Approx. 140g			

※Environment resistance is rated at no freezing or condensation.

■ Specifications

◎ Sensor connector type

Model	Basic unit	ARD-DI08N-4S	ARD-DI08P-4S	ARD-DO08N-4S	ARD-DO08P-4S
	Expansion unit	ARX-DI08N-4S	ARX-DI08P-4S	ARX-DO08N-4S	ARX-DO08P-4S
Power supply		Rated voltage: 24VDC \equiv , Voltage range: 12-28VDC \equiv			
Power consumption		Max. 3W			
I/O points		NPN input 8-point	PNP input 8-point	NPN output 8-point	PNP output 8-point
Control I/O	Voltage	10-28VDC \equiv input		10-28VDC \equiv output (voltage drop: max. 0.5VDC \equiv)	
	Current	10mA/point (sensor current: 150mA/point)		0.3A/point (leakage current: max. 0.5mA)	
	COMMON method	8-point, common			
Insulation resistance		Over 200M Ω (at 500VDC megger)			
Noise immunity		\pm 240V the square wave noise (pulse width: 1 μ s) by the noise simulator			
Dielectric strength		1,000VAC 50/60Hz for 1 min (between external terminals and case)			
Vibration		1.5mm amplitude at frequency of 10 to 55 Hz (for 1 min) in each X, Y, Z direction for 2 hours			
Shock		500m/s ² (approx. 50 G) in each X, Y, Z direction for 3 times			
Environment	Ambient temp.	-10 to 50°C, storage: -25 to 75°C			
	Ambient humi.	35 to 85%RH, storage: 35 to 85%RH			
Protection structure		IP20 (IEC standard)			
Protection circuit		Surge, short-circuit, overheat and ESD protection, reverse polarity protection circuit			
		Overcurrent protection circuit (operated at min. 0.17A)		Overcurrent protection circuit (operated at min. 0.7A)	
Indicator		Network status (NS) LED (green, red), unit status (MS) LED (green, red), I/O status LED (input: green, output: red)			
Material		Front case, body case: Polycarbonate			
Mounting		DIN rail or bolt mounting type			
Approval		 DeviceNet			
Unit weight	Basic unit	Approx. 64g	Approx. 64g	Approx. 65g	Approx. 67g
	Expansion unit	Approx. 56g	Approx. 57g	Approx. 58g	Approx. 59g

※Environment resistance is rated at no freezing or condensation.

■ DeviceNet Communication

Item	Specifications
Communication	I/O Slave messaging (Group 2 Only slave) · Poll command: Yes · Bit_strobe command: Yes · Cyclic command: Yes · COS command: Yes
Communication distance	Max. 500m (125kbps), Max. 250m (250kbps), Max. 100m (500kbps)
NODE ADDRESS setting	Max. 64 nodes (set by the front rotary switch)
Communication speed ^{※1}	125, 250, 500kbps (automatically set when connecting with Master)
Insulation	I/O and inner circuit: Photocoupler isolated, DeviceNet and inner circuit: non-isolated, DeviceNet power: non-isolated
DeviceNet power	· Rated voltage: 24VDC \equiv · Voltage range: 12-28VDC \equiv · Power consumption: max. 3W
Approval	ODVA Conformance tested

※1. The communication speed is automatically set to the communication speed of the Master (PC, PLC, etc.) When changing the communication speed during operation, the network status (NS) LED flashes in red and communication is not possible.

■ Communication Distance

Baud rate	Max. network length	Max. branch line length	Max. extended branch line length
125kbps	500m	6m	156m
250kbps	250m	6m	78m
500kbps	100m	6m	39m

SENSORS

CONTROLLERS

MOTION DEVICES

SOFTWARE

(J) Temperature Controllers

(K) SSRs

(L) Power Controllers

(M) Counters

(N) Timers

(O) Digital Panel Meters

(P) Indicators

(Q) Converters

(R) Digital Display Units

(S) Sensor Controllers

(T) Switching Mode Power Supplies

(U) Recorders

(V) HMIs

(W) Panel PC

(X) Field Network Devices

ARD-D Series

■ Unit Description

◎ Basic unit

● Standard terminal block type

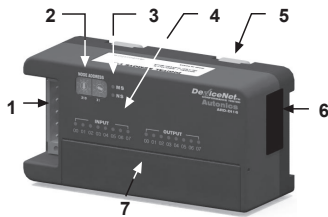

● Sensor connector type

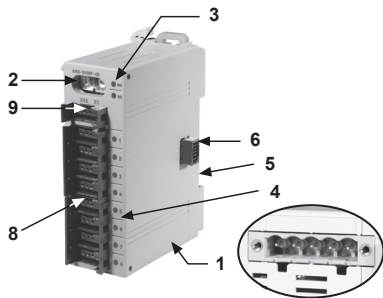

1. DeviceNet connector

No.	Color	For	Organization
5	Red	24VDC (+)	
4	White	CAN_H	
3	None	Shield	
2	Blue	CAN_L	
1	Black	24VDC (-)	

2. Rotary switch for node address

: Rotary switch for setting node address.
×10 represents tens digit and ×1 represents ones digit.

3. Status LED: It displays the status of unit (MS) and network (NS).

4. I/O status LED: It displays each I/O status.

5. Rail lock: It is used for mounting DIN rail or with bolt.

6. Connector output part: It connects an expansion unit.

7. I/O terminal block: It is used for connecting external device I/O.

8. Sensor connector: It is used for connecting external device I/O.

9. External power connector: It is used for supplying external power.

◎ Expansion unit

● Standard terminal block type

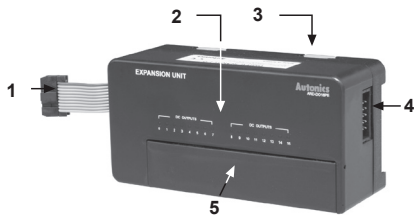

● Sensor connector type

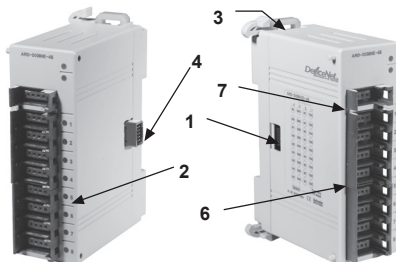

1. Connector input part

: It connects expansion unit and is joined into expansion connector output.

2. I/O status LED: It displays each I/O status.

3. Rail lock: It is used for mounting DIN rail or with bolt.

4. Connector output part: It connects an expansion unit.

5. I/O terminal block: It is used for connecting external device I/O.

6. Sensor connector: It is used for connecting external device I/O.

7. External power connector: It is used for supplying external power

■ Status LED

(☀): ON, (⚡): Flash, (●): OFF

Item	LED status		Description
	Red	Green	
Unit status (MS) LED	☀	●	Unrecoverable error
	⚡	●	Recoverable error & communication error of expansion unit
	●	☀	Normal operation
	●	●	Power is not supplied
Network status (NS) LED	●	⚡	Normal standby
	●	☀	Network On-Line
	☀	●	Duplicate, MAC ID / Bus-Off
	⚡	●	Time Out
	●	●	Network Off-Line

DeviceNet Digital Remote I/O

I/O Circuit Diagram

Standard terminal block type

Type	DeviceNet connector	Inner circuit	External connections
NPN input			
PNP input			
AC input			
NPN output			
PNP output			
Relay output			
SSR output			

SENSORS

CONTROLLERS

MOTION DEVICES

SOFTWARE

(J) Temperature Controllers

(K) SSRs

(L) Power Controllers

(M) Counters

(N) Timers

(O) Digital Panel Meters

(P) Indicators

(Q) Converters

(R) Digital Display Units

(S) Sensor Controllers

(T) Switching Mode Power Supplies

(U) Recorders

(V) HMIs

(W) Panel PC

(X) Field Network Devices

ARD-D Series

■ I/O Circuit Diagram

⊙ Sensor connector type

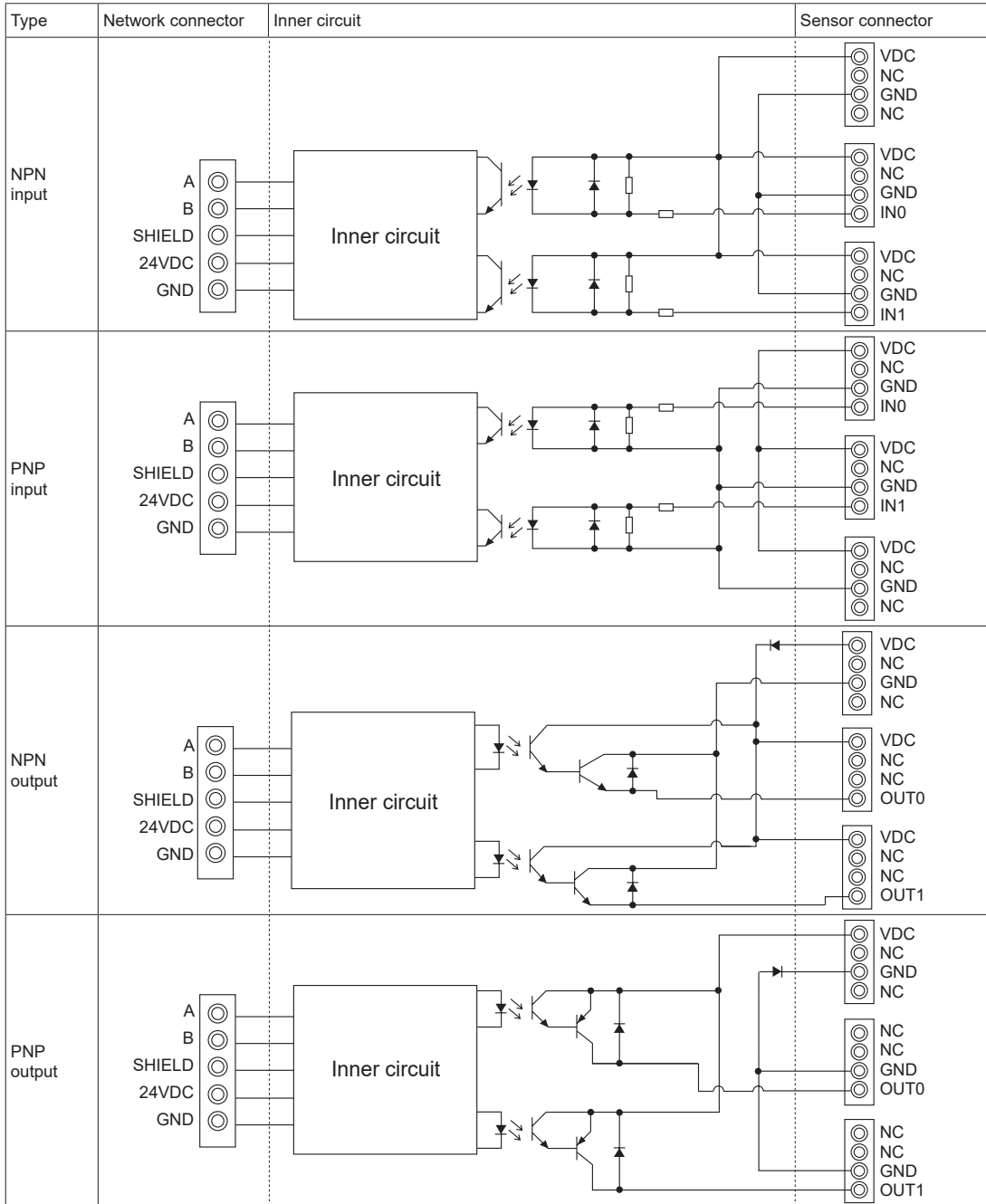

DeviceNet Digital Remote I/O

■ Connections

◎ Standard terminal block type

- ※ When wiring the communication connector, use cable and tap which meet the DeviceNet standard and tighten the connector screw with a tightening torque of 0.5N·m.
- ※ When wiring the input/output terminal, tighten the connector screw with a tightening torque of 0.5N·m.

● ARD-DI08A (E)

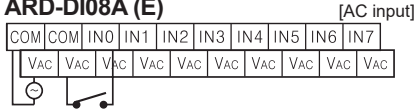

● ARD-DI16N (E)

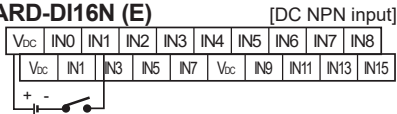

● ARD-DO08R (E)

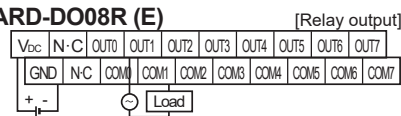

● ARD-DO16N (E)

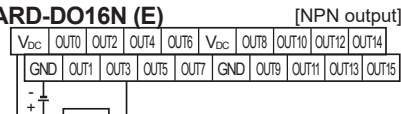

● ARD-DX16N (E)

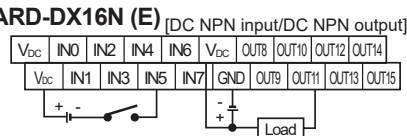

● ARD-DI16P (E)

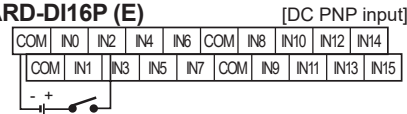

● ARD-DO08S (E)

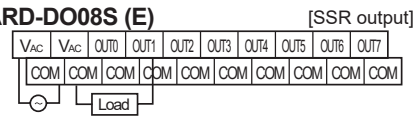

● ARD-DO16P (E)

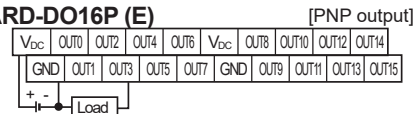

● ARD-DX16P (E)

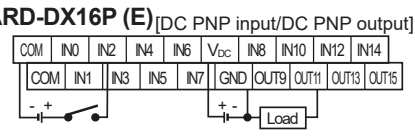

◎ Sensor connector type

- ※ When wiring the communication connector, use cable and tap which meet the DeviceNet standard and tighten the connector screw with a tightening torque of 0.5N·m.

● AR□-DI08N-4S

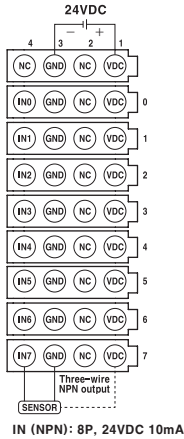

● AR□-DI08P-4S

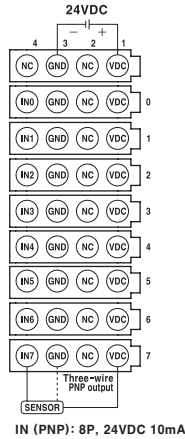

● AR□-DO08N-4S

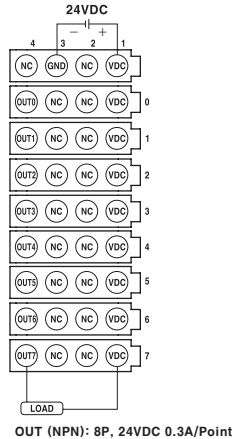

● AR□-DO08P-4S

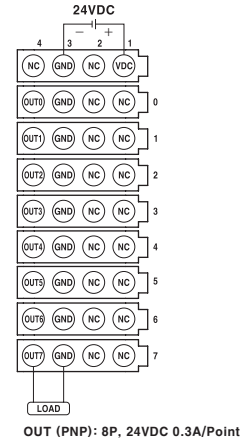

■ Terminating Resistance

- 120Ω ● 1% of metallic film ● 1/2W

- ※ Do not install terminating resistance on the unit, or it may cause network terminating problem (impedance can be too high or low) and trouble.
- ※ Connect terminating resistance on the both ends of the trunk line.

SENSORS
CONTROLLERS
MOTION DEVICES
SOFTWARE
(J) Temperature Controllers
(K) SSRs
(L) Power Controllers
(M) Counters
(N) Timers
(O) Digital Panel Meters
(P) Indicators
(Q) Converters
(R) Digital Display Units
(S) Sensor Controllers
(T) Switching Mode Power Supplies
(U) Recorders
(V) HMIs
(W) Panel PC
(X) Field Network Devices

ARD-D Series

■ Dimensions

※Same dimensions are applied to both basic and expansion unit.
 ※Tightening torque for mounting bolts: 1.8 to 2.5N·m

(unit: mm)

◎ Standard terminal block type

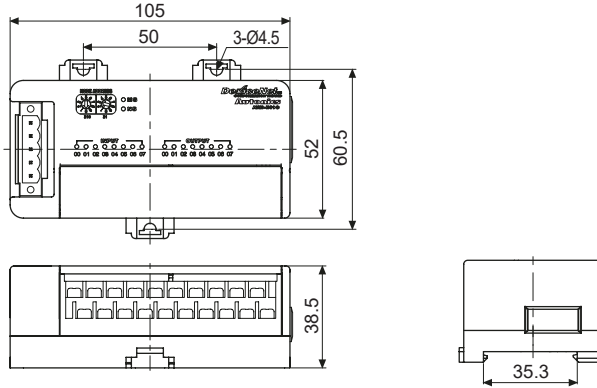

● Panel cut-out

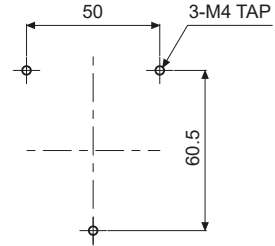

◎ Sensor connector type

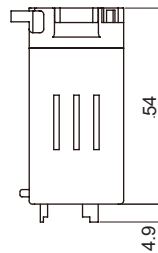

● Expansion connector

(supplied only for expansion unit)

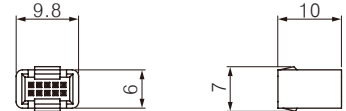

● Rail lock position: mounting with bolt

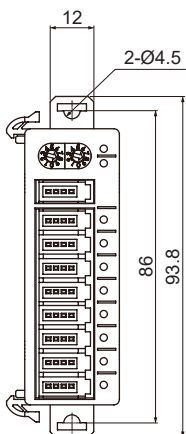

● Rail lock position: mounting on DIN rail

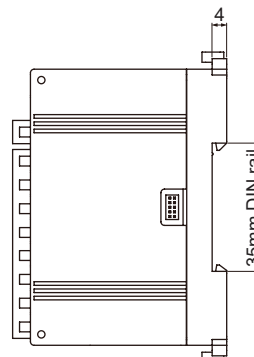
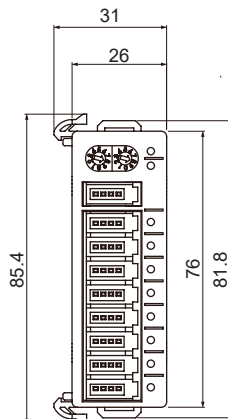

● Panel cut-out



■ Setup and Installation

◎ Setting Node address

- ① Two rotary switches are used for setting node address. The ×10 switch represents tens digit and the ×1 switch represents ones digit. The node address can be set 00 to 63.
- ② After setting the desired node address, re-supply the unit power for applying the changed node address.

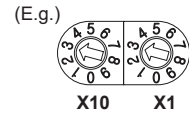

The X10 and X1 switches point both at "3", so the address is "33".

- ※The NODE ADDRESS of the connected unit must not be duplicated.
When changing the NODE ADDRESS during operation, the unit status (MS) LED flashes in red and the unit communicates to the NODE ADDRESS before the change.

◎ Unit Installation

● Mounting on panel

- ① Pull rail locks (standard terminal block type: 3, sensor connector type: 2) on the rear part of a unit, there are fixing bolt hole.
- ② Place the unit on a panel to be mounted.
- ③ Make holes on fixing bolt positions.
- ④ Fasten the bolt to fix the unit tightly.
Tightening torque should be below 0.5N·m.

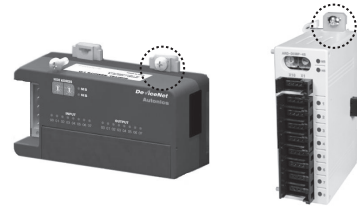

● Mounting on DIN rail

- ① Pull rail locks (standard terminal block type: 3, sensor connector type: 2) on the rear part of unit.
- ② Place the unit on DIN rail to be mounted.
- ③ Press rail locks to fix the unit tightly.

● Connection of basic and expansion units (standard terminal block type)

- ① Turn OFF the power of a Basic unit.
- ② Place an expansion unit to be installed next to the basic unit.
- ③ Connect the cable of expansion unit to the connector of a basic unit.
- ④ Install a connected expansion unit as the right figures.
- ⑤ Supply the power to the basic unit.



※Re-supply the power of a basic unit and it recognizes expansion units.

● Connection of basic and expansion units (sensor connector type)

- ① Turn OFF the power of the basic unit.
 - ② Remove a cover of connector for extension with nippers, etc.
 - ③ Connect connector input part of an expansion unit and connector output part of a basic unit with a connector which is enclosed with an expansion unit box.
 - ④ Install a connected expansion units as the right figure.
 - ⑤ Supply the power to the basic unit.
- ※Re-supply the power of a basic unit and it recognizes expansion units.



■ Cautions during Use

1. Follow instructions in 'Cautions during Use'. Otherwise, it may cause unexpected accidents.
2. 24VDC power supply should be insulated and limited voltage/current or Class 2, SELV power supply device.
3. Keep away from high voltage lines or power lines to prevent inductive noise.
In case installing power line and input signal line closely, use line filter or varistor at power line and shielded wire at input signal line.
Do not use near the equipment which generates strong magnetic force or high frequency noise.
4. Do not connect or disconnect the expansion unit when power is being supplied.
5. This unit may be used in the following environments.
 - ①Indoors (in the environment condition rated in 'Specifications')
 - ②Altitude max. 2,000m
 - ③Pollution degree 2
 - ④Installation category II

SENSORS
CONTROLLERS
MOTION DEVICES
SOFTWARE

(J) Temperature Controllers
(K) SSRs
(L) Power Controllers
(M) Counters
(N) Timers
(O) Digital Panel Meters
(P) Indicators
(Q) Converters
(R) Digital Display Units
(S) Sensor Controllers
(T) Switching Mode Power Supplies
(U) Recorders
(V) HMIs
(W) Panel PC
(X) Field Network Devices